

ASSEMBLY INSTRUCTION
MODEL : 6801 / WARDROBE

Before you begin, please follow assembly instruction carefully.
 Then follow them step by step.

STEP 1

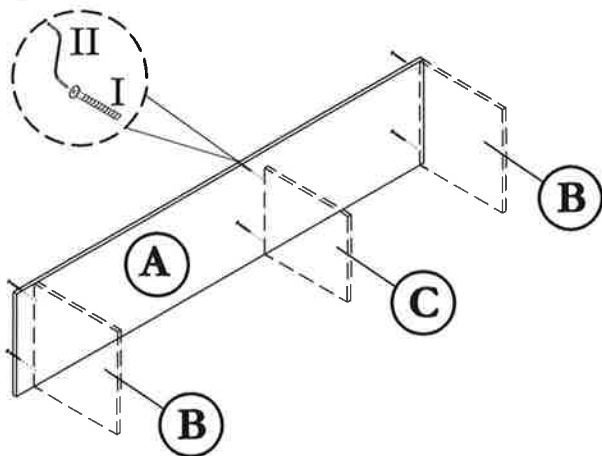

STEP 2

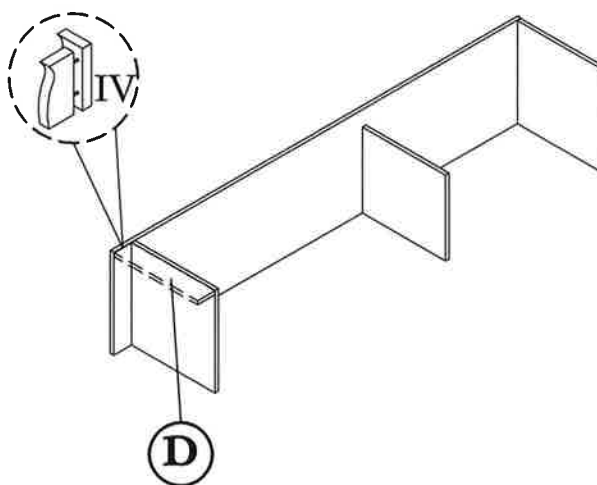

STEP 3

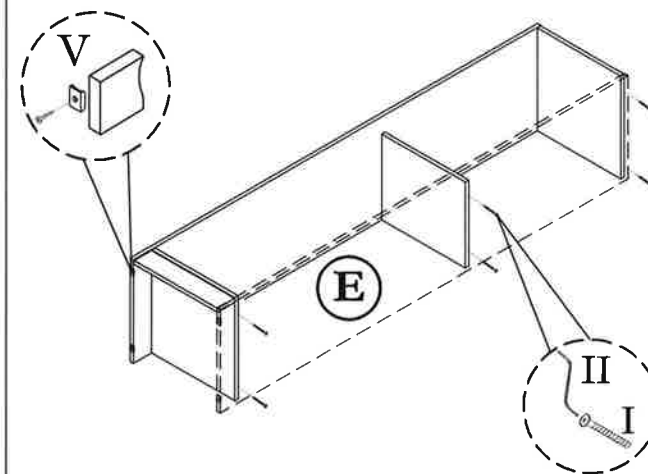

STEP 4

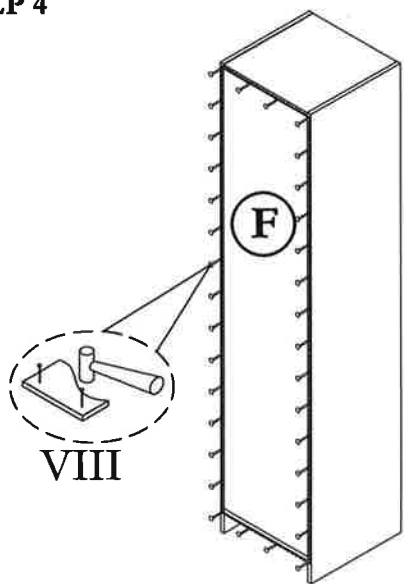

STEP 5

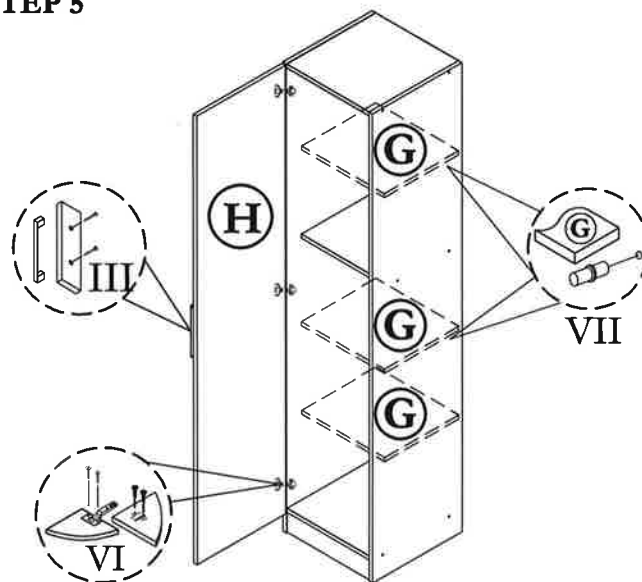



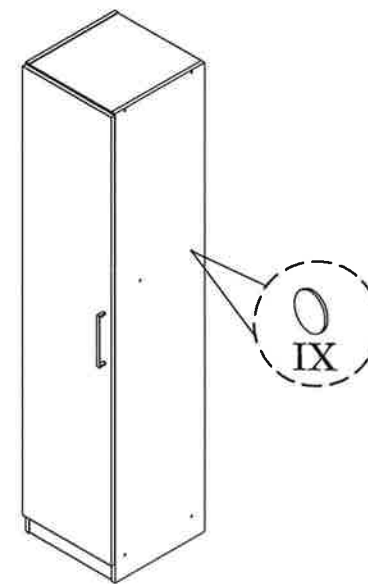



STEP 6



HARDWARE LIST

NO	DESCRIPTION	QTY
I	JCBCW SCREW M6.3 x 50	12pcs
II	M4 ALLEN KEY	1pc
III	HANDLE & SCREW M3.5 x 30	1sets

IV	M8 X 30 WOOD DOWEL		4pcs
V	PLASTIC PIN & SCREW M3.5 x 16		4sets
VI	HINGE (A) & SCREW M3.5 x 16		3sets
VII	SHELF SUPPORT		12pcs
VIII	NAIL		50pcs

IX	STICKER		12pcs

CAUTION:

To clean use soft, dry cloth. Do not use detergent or chemicals
Avoid contact with water and direct sunlight.
To be assembled on a soft, dry, clean and smooth surface.

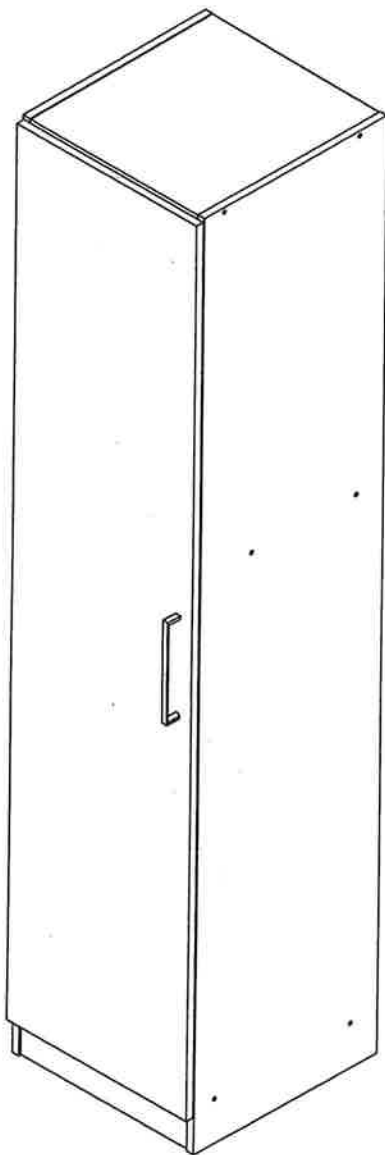

COMPLETE SET

ORDERING REPAIR PARTS

In order to obtain smooth and rapid service when ordering repair parts,
please give full attention to the following of PART NUMBER.

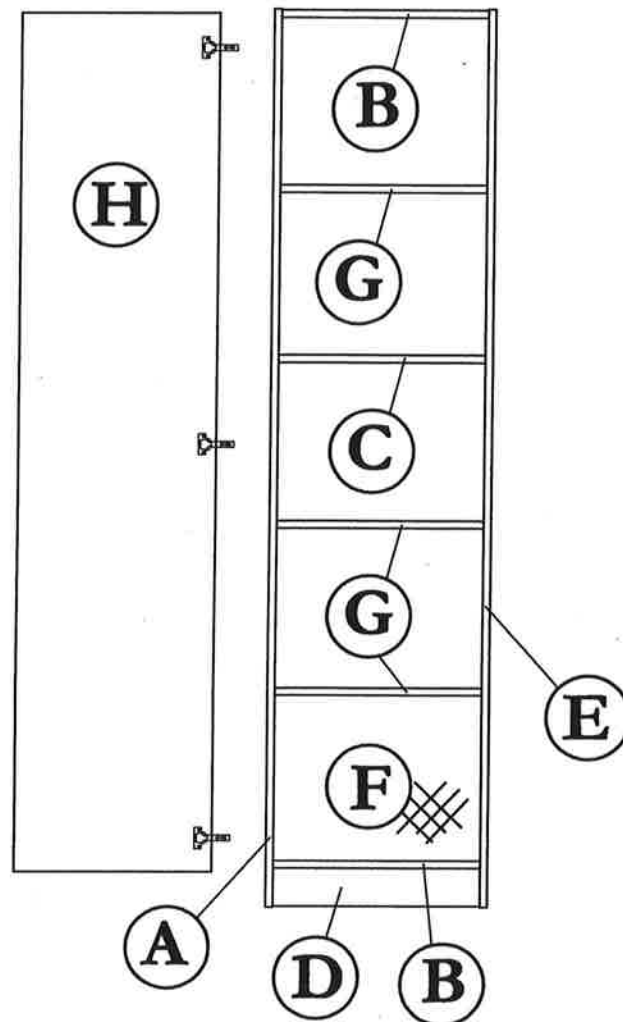

NO	DESCRIPTION	QTY
A	LEFT SIDE	01
B	SHELF	02
C	CENTRE SHELF	01
D	LEG	01
E	RIGHT SIDE	01

NO	DESCRIPTION	QTY
F	BACK	01
G	MOVABLE SHELF	03
H	DOOR	01