

ASSEMBLY INSTRUCTION

ITEM CODE 3310-2

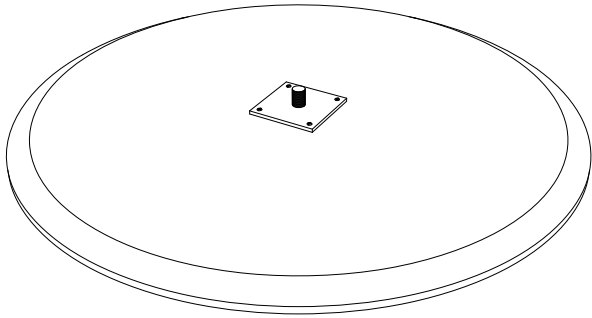

Ax01

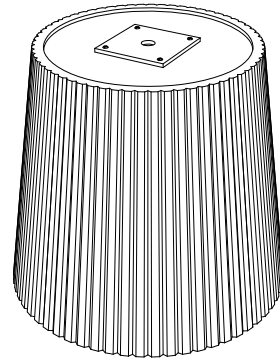

Bx01

STEP - 01

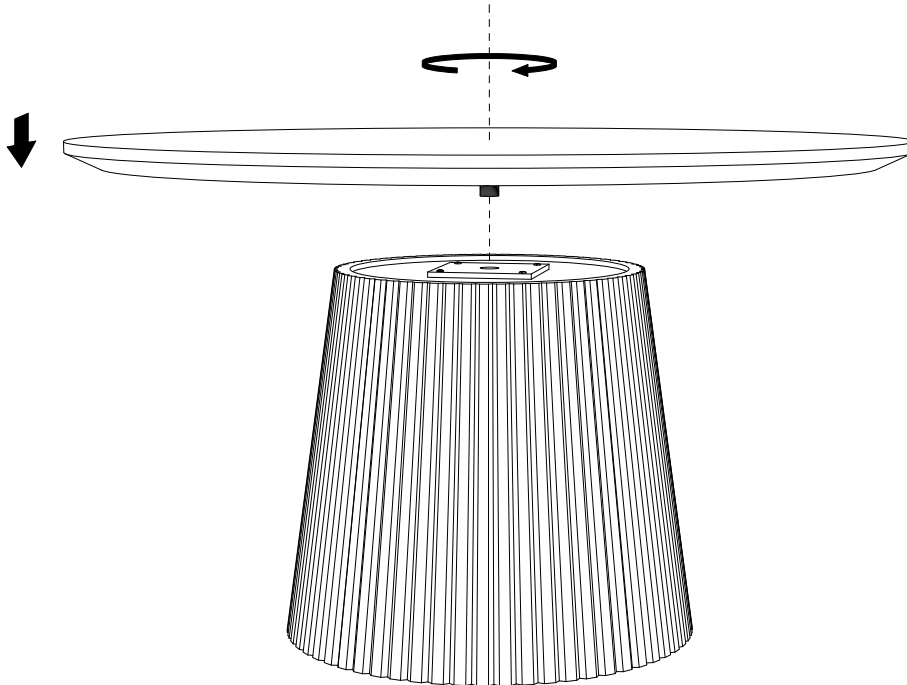

Final - 02

