

ASSEMBLY INSTRUCTION

89514

Important

**Please inspect all items carefully before assembling.
If for any reason you need to return this item,
you must return it in its original packaging.
Assembled items cannot be returned**

**IMPORTANT NOTE: *PLACE ALL PARTS ON A CLEAN AND SMOOTH SURFACE
SUCH AS A RUG OR CARPET TO AVOID THE PARTS
FROM BEING SCRATCHED.
*KINDLY FOLLOW THE ASSEMBLY INSTRUCTIONS STEP
BY STEP.
*DO NOT TIGHTEN ALL SCREWS UNTIL THE BED IS FULLY
SET-UP.**

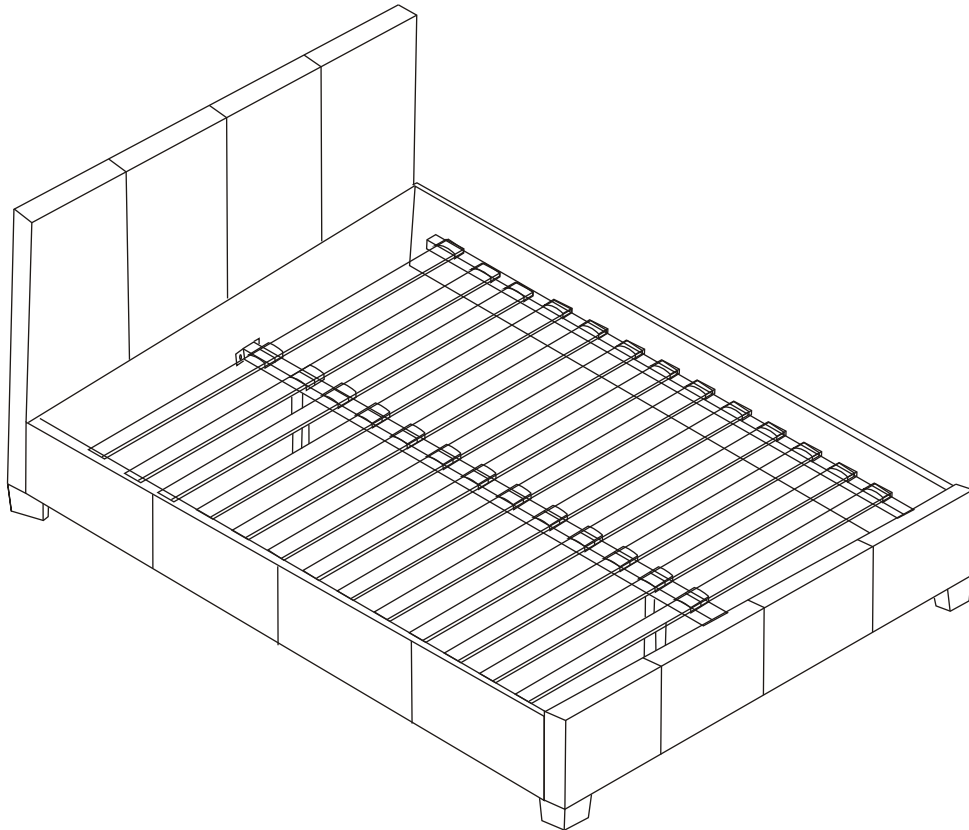

Part list

① Headboard 1pc

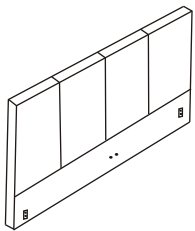

② Footboard 1pc

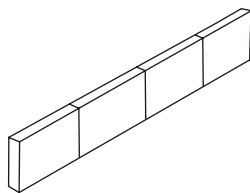

③ Side Rail 2pcs

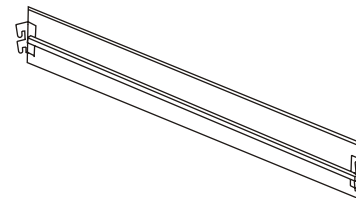

④ Double Plastic Cap 14pcs

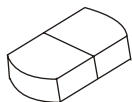

⑤ Centre Support Bar 1pc



⑥ Support Leg 2pcs

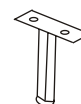

⑦ Slat 28 pcs

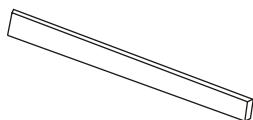

⑧ Single Plastic Cap 28pcs



⑨ Left Leg 2pcs



⑩ Right Leg 2pcs

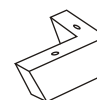

Hardware list

A Bolt M8*30mm 12pcs



B Bolt M8*40mm 4pcs



C Nut M8*13mm 4pcs



D Spring Washer 8pcs



E Flat Washer 12pcs



F Allen Key M5 1pc



G Spanner 1pc



H Bolt M8*50mm 4pcs



I Screw M4*70mm 4pcs



J Screw Driver (not provided)



STEP 1 FIXING LEGS TO HEADBOARD AND FOOTBOARD

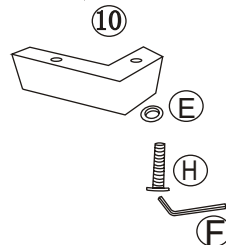
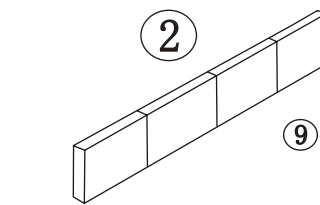
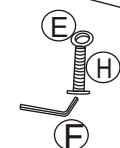
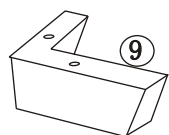
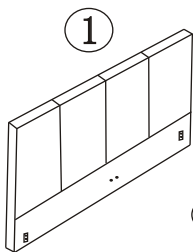

STEP 2 FIXING SUPPORT LEGS TO CENTRE SUPPORT BAR

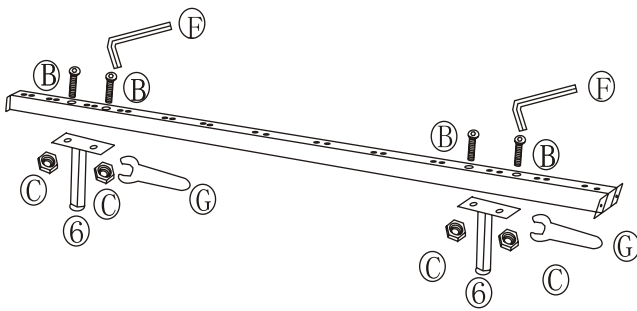

STEP 3 FIXING SIDE RAILS AND CENTRE SUPPORT BAR TO HEADBOARD AND FOOTBOARD

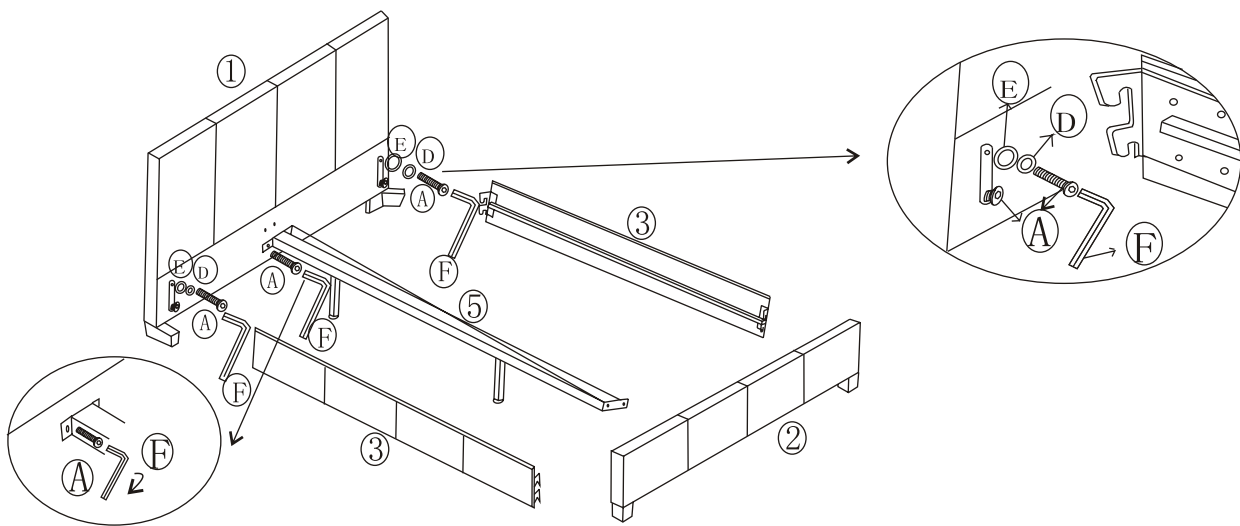

STEP 4 FIXING LEGS TO SIDE RAILS AND FIXING PLASTIC CAPS AND SLATS

